

BEAU MONDE

Beau Monde Manicure Table

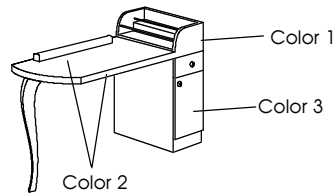

Model	BN102	
List Price		
Specify Pulls	Group 1	Group 2
With Metal Leg (specify finish)	\$2,148	\$2,197
With Wood Leg (specify finish)	\$2,076	\$2,125
Specifications		
Shipping weight (lbs.)	124	
Width (in.)	42	
Depth (in.)	18	
Height (in.)	34	
Specify Colors Armrest pad colors only. NB707 Black FA705 Pearl Grey FA731 Bahama Beige	Color 1: Nail polish display. Color 2: Work top and edge. Color 3: Storage cabinet. Armrest pad, 3Z400025.	
Features	Manicure table with a drawer and closed storage with an adjustable shelf. Pad, 3Z400025 included.	

<p>Distressed Brush Steel or Black Wrought Iron</p> <p>Black, Walnut, Dark Mahogany, Traditional Cherry, Cherry, Beech, Honey Maple, Natural Maple, Light Maple, Unfinished.</p>	<p>Group 1</p> <p>P-15 Whistle</p> <p>P-16 Crescent</p> <p>P-17 Mushroom</p> <p>P-09 Round</p> <p>P-14 Oval</p> <p>P-12 Football</p>	<p>Group 2</p> <p>P-03 Frosted Flower</p> <p>P-04 Frosted Blue Flower</p> <p>P-05 Dented Moon</p> <p>P-06 Silver Shell</p> <p>P-07 Silver Ripple</p> <p>P-11 Silver Ball</p> <p>P-13 Spiral</p>
----------------------------------------------------------------------------------------------------------------------------------------------------------------------------------	---------------------------------------------------------------------------------------------------------------------------------------------	--------------------------------------------------------------------------------------------------------------------------------------------------------------------------------------------------------

BLEND

Blend Manicure Table

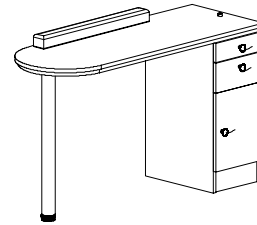
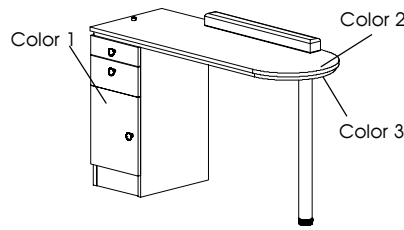

Model

BLND02

List Price

Specify Pulls

Group 1

Group 2

\$1,319

\$1,391

Specifications

Width (in.)

49⁷/₈

Depth (in.)

17

Height (in.)

29¹/₄

Specify Colors

Armrest pad colors only.
NB707 Black
FA705 Pearl Grey
FA731 Bahama Beige

Color 1: Main
Color 2: Work top and edge.
Color 3: Top reveal.

Armrest pad, 3Z400025.

Features

Manicure table designed to be used by left or right-handed manicurist. Top assembly is shipped not attached. Features: two drawers, one is divided and closed storage with an adjustable shelf, lamp grommet, duplex outlet and chrome leg. Pad, 3Z400025 included.

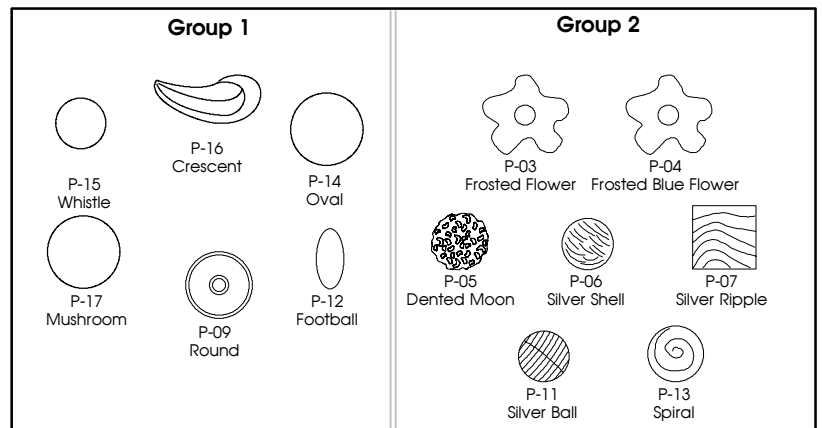

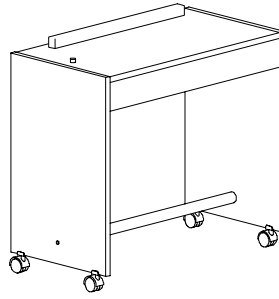
BURKE**Manicure Table**

Model	BU102
List Price	\$638
Specifications	
Width (in.)	33 ⁵ / ₈
Depth (in.)	18
Height (in.)	30
Specify Colors	Main (laminated or thermofuse) Armrest pad vinyl fabric color.
Features	Manicure table features lamp grommet, four casters, 3Z400028 armrest pad

CARMEL, COSMOS

**Carmel
Manicure Table**

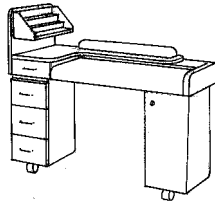

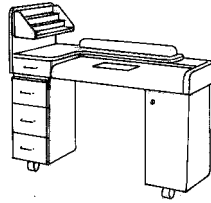

**Carmel Vented
Manicure Table**

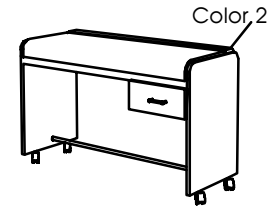

Cosmos Manicure Table

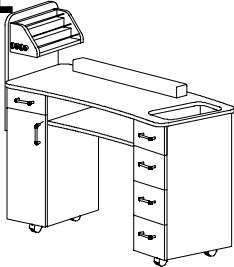
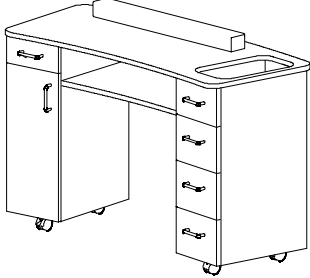

Model	CM01B		CM02B		1622-36QA		1622-42QA		1622-48QA	
List Price	Grade 1	Grade 2	Grade 1	Grade 2	Grade 1	Grade 2	Grade 1	Grade 2	Grade 1	Grade 2
	\$1,911	\$1,960	\$2,294	\$2,343	\$1,260	\$1,309	\$1,328	\$1,377	\$1,328	\$1,377
With lamp model 1058	\$1,968	\$2,017	\$2,351	\$2,400	\$1,317	\$1,366	\$1,385	\$1,434	\$1,385	\$1,434
Replacement Part Filter 7106777			\$39							
Specifications										
Shipping weight (lbs.)	158		160		86		95		104	
Width (in.)	46 ¹ / ₂		46 ¹ / ₂		36		42		48	
Depth (in.)	18		18		19 ¹ / ₂		19 ¹ / ₂		19 ¹ / ₂	
Height (in.)	38 ³ / ₄		38 ³ / ₄		28		28		28	
Specify colors	1. Main. Armrest pad, 3Z400025.		1. Main. Armrest pad, 3Z400025.		1. Main. 2. Trim: Accent strip and edgeband on end panels Armrest pad.					
Features	Nail color display. Grommet for lamp. Bottle well. Upholstered armrest pad. Four drawers on left hand side. Locking storage on right hand side. Dual wheel casters.		Recessed vent and electrical outlet. Nail color display. Grommet for lamp. Bottle well. Upholstered armrest pad. Four drawers on left hand side. Locking storage on right hand side. Dual wheel casters.		Removable upholstered client armrest pad extends full width of table. One drawer. Four casters--two lock. Chrome tube footrest. Lamp socket. Order armrest pad 3Z400003 for model 1622-36QA. Order armrest pad 3Z400002 for model 1622-42QA. Order armrest pad 3Z400001 for model 1622-48QA.					

<p>CURVE</p>  <p>Shown with optional nail rack</p>	<p>Manicure Table</p> 	
<p>Model</p>	<p>CR102</p>	<p>NR101</p>
<p>List Price with optional nail polish rack</p>	<p>\$1,504 \$2,014</p>	<p>\$510</p>
<p>Specifications Width (in.) Depth (in.) Height (in.)</p>	<p>49¹/₄ 21⁵/₈ 30³/₄</p>	<p>16¹/₈ 24 7³/₄</p>
<p>Specify Colors</p>	<p>Main (laminated or thermofuse) Armrest pad vinyl fabric color.</p>	<p>Color 1: Main (laminated or thermofuse)</p>
<p>Features</p>	<p>Features: open center shelf, four drawers on right side, one drawer and closed storage with adjustable shelf on left side, armrest pad, bottle well. Nail polish rack optional.</p>	<p>Features: brush holders on side and three stepped shelves to hold polish.</p>

EMBASSY, GINGER	Embassy Manicure Table Single		Embassy Manicure Table Double		Ginger Manicure Table	
Model	D902B		D902-2B		GG01	
	Grade 1	Grade 2	Grade 1	Grade 2	Grade 1	Grade 2
List Price	\$1,648	\$1,697	\$2,060	\$2,109	\$1,618	\$1,667
Specifications Shipping weight (lbs.) Width (in.) Depth (in.) Height (in.)	85 52 40 28		106 86 40 28		114 48 15 30	
Specify color	1. Laminate 2. Specify vinyl color for armrest pad, 3Z400025. 3. Paint:		1. Main. 2. Specify vinyl color for armrest pad, 3Z400025. 3. Paint		1. Main: Cabinet and under glass. Specify vinyl color for armrest pad, 3Z400015.	
Features	Glass top on chrome steel support pivots on cabinet. Top dimensions 51" w x 16" d. Storage below with adjustable shelf.		Two glass tops on chrome steel supports pivot on cabinet. Each top dimensions 51" w x 16" d. Storage below with adjustable shelf. One door on each side of the cabinet.		Glass top, Brushed chrome legs on left-hand side. Two drawers and storage on right side as sitting behind.	

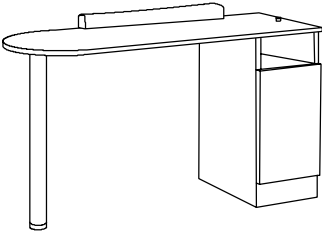
<p>GAZE</p>	<p>Manicure Table</p> 
<p>Model</p>	<p>GAZ102</p>
<p>List Price</p>	<p>\$896</p>
<p>Specifications Width (in.) Depth (in.) Height (in.)</p>	<p>49⁷/₈ 17 29¹/₄</p>
<p>Specify Colors Armrest pad colors only: NB707 Black FA705 Pearl Grey FA731 Bahama Beige</p>	<p>Color 1: Main Armrest pad: 3Z400025</p>
<p>Features</p>	<p>Features: door with adjustable shelf, nail pad and chrome leg.</p>

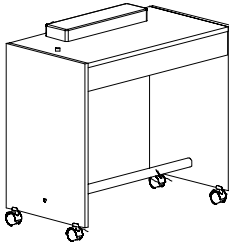
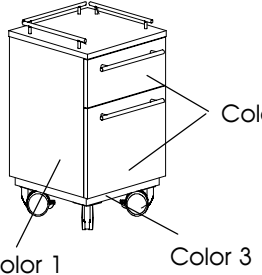
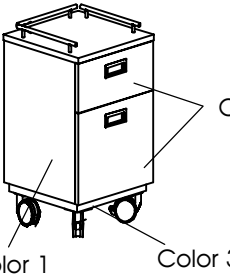
KALLI	Manicure Table 	Manicure Rollabout 	Manicure Rollabout 
Model	KA102	KA103	KA203
List Price	\$664	\$924	\$858
Specifications Width (in.) Depth (in.) Height (in.)	33 ⁵ / ₈ 18 30	16 ¹ / ₈ 16 ¹ / ₈ 24 ¹ / ₄	16 ¹ / ₈ 16 ¹ / ₈ 24 ¹ / ₄
Specify Colors Armrest pad colors only: NB707 Black FA705 Pearl Grey FA731 Bahama Beige	Color 1: Main Armrest pad: 3Z400028	1. Main 2. Drawer faces 3. Base panel edging	1. Main 2. Drawer faces 3. Base
Features	Features casters, lamp grommet and armrest pad.	Features locking casters and two drawers. Stainless steel pulls.	Features recessed pulls, locking casters and two drawers.

KALLISTA

Kallista Manicure Table

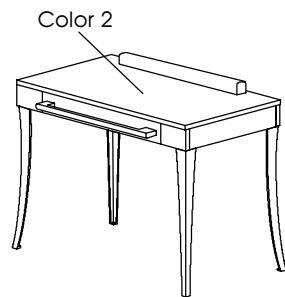

Kallista Manicure Table

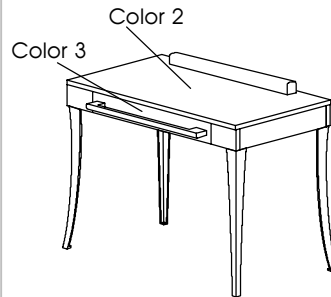

Kallista Manicure Caddy

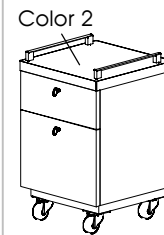

Kallista Manicure Caddy

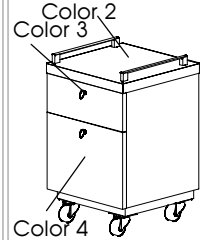

Model	KT102-32	KT102-39	KT102-44	KT102-32-D	KT102-39-D	KT102-44-D	KT103	KT103-D
Standard List Price	\$1,578	\$1,606	\$1,686	\$1,578	\$1,606	\$1,686	\$1,262	\$1,262
Specifications								
Width (in.)	32	39	44	32	39	44	16 ¹ / ₈	16 ¹ / ₈
Depth (in.)	18	18	18	18	18	18	16 ¹ / ₈	16 ¹ / ₈
Height (in.)	29 ¹ / ₄	29 ¹ / ₄	29 ¹ / ₄	29 ¹ / ₄	29 ¹ / ₄	29 ¹ / ₄	23	23
Specify color	1. Cabinet. 2. Top Armrest pad, 3Z400025			1. Cabinet. 2. Top 3. Drawer front Armrest pad, 3Z400025			1. Cabinet. 2. Top	
Features	One center drawer 23 ³ / ₈ inches wide. Four metal legs with adjustable glide. Legs finished in soft silver paint. Armrest pad included.			Center drawer face may be trim color. Drawer 23 ³ / ₈ inches wide. Four metal legs with adjustable glide. Legs finished in soft silver paint. Armrest pad included.			Two drawers: one 12 inches, one 6 inches.	
							Drawer fronts may be specified as trim colors. Two drawers: one 12 inches, one 6 inches.	

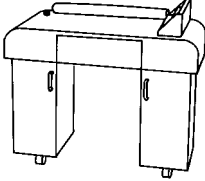
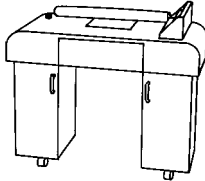

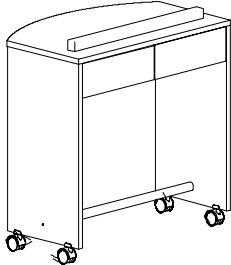





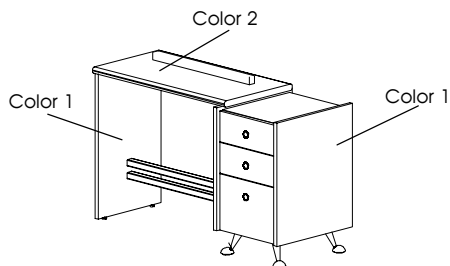





























MONTEREY	Monterey Manicure Table		Monterey Manicure Table vented	
				
Model	MY01C		MY02C	
List Price	Grade 1	Grade 2	Grade 1	Grade 2
	\$1,371	\$1,420	\$1,693	\$1,742
With lamp 1058	\$1,428	\$1,477	\$1,749	\$1,798
Replacement Part				
Filter 7106777			\$39	\$39
Specifications				
Shipping weight (lbs.)	120		121	
Width (in.)	40 ³ / ₄		40 ³ / ₄	
Depth (in.)	17		17	
Height (in.)	31 ³ / ₄		31 ³ / ₄	
Specify color	1. Main. Armrest pad, 3Z400025.		1. Main. Armrest pad, 3Z400025.	
Features	Removable nail color display. No electrical. Grommet for lamp. Upholstered armrest. Center drawer. Storage on both sides. Adjustable shelves on both sides. Dual wheel casters.		Recessed vent and duplex electrical outlet. Hardwire on site. Removable nail color display. No electrical. Grommet for lamp. Upholstered armrest. Center drawer. Storage on both sides. Adjustable shelves on both sides. Dual wheel casters.	



<p>PACIFIC</p>	<p>Manicure Table</p> 
<p>Model</p>	<p>PA102</p>
<p>List Price</p>	<p>\$788</p>
<p>Specifications Width (in.) Depth (in.) Height (in.)</p>	<p>30 18 30</p>
<p>Specify Colors</p>	<p>Color 1: Main (laminated or thermofuse) Armrest pad</p>
<p>Features</p>	<p>Features: two drawers, footrest, armrest pad and casters.</p>

PLAZA

Plaza Manicure Table

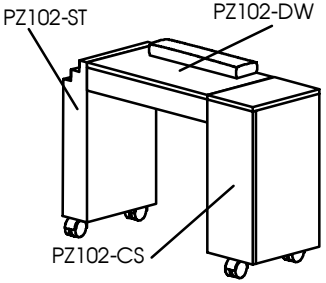
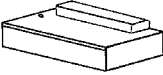
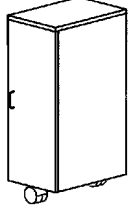

<p>Model</p>	<p>PLA02</p>																									
<p>List Price Specify Pulls</p>	<p>Group 1</p>	<p>Group 2</p>																								
	<p>\$1,658</p>	<p>\$1,707</p>																								
<p>Specifications Width (in.) Depth (in.) Height (in.)</p>	<p>49³/₄ 20 29¹¹/₁₆</p>																									
<p>Specify Colors Armrest pad colors only. NB707 Black FA705 Pearl Grey FA731 Bahama Beige</p>	<p>Color 1: Main Color 2: Work top Armrest Pad</p>																									
<p>Features</p>	<p>Features: three drawers, nickel legs and gunmetal powder coated supports bars.</p> <p>Armrest pad: 3Z400025</p> <div data-bbox="753 1526 1555 1948" style="border: 1px solid black; padding: 10px;"> <table style="width: 100%; text-align: center;"> <tr> <th colspan="3">Group 1</th> <th colspan="3">Group 2</th> </tr> <tr> <td> P-15 Whistle</td> <td> P-16 Crescent</td> <td> P-14 Oval</td> <td> P-03 Frosted Flower</td> <td> P-04 Frosted Blue Flower</td> <td></td> </tr> <tr> <td> P-17 Mushroom</td> <td> P-09 Round</td> <td> P-12 Football</td> <td> P-05 Dented Moon</td> <td> P-06 Silver Shell</td> <td> P-07 Silver Ripple</td> </tr> <tr> <td></td> <td></td> <td></td> <td> P-11 Silver Ball</td> <td> P-13 Spiral</td> <td></td> </tr> </table> </div>		Group 1			Group 2			 P-15 Whistle	 P-16 Crescent	 P-14 Oval	 P-03 Frosted Flower	 P-04 Frosted Blue Flower		 P-17 Mushroom	 P-09 Round	 P-12 Football	 P-05 Dented Moon	 P-06 Silver Shell	 P-07 Silver Ripple				 P-11 Silver Ball	 P-13 Spiral	
Group 1			Group 2																							
 P-15 Whistle	 P-16 Crescent	 P-14 Oval	 P-03 Frosted Flower	 P-04 Frosted Blue Flower																						
 P-17 Mushroom	 P-09 Round	 P-12 Football	 P-05 Dented Moon	 P-06 Silver Shell	 P-07 Silver Ripple																					
			 P-11 Silver Ball	 P-13 Spiral																						

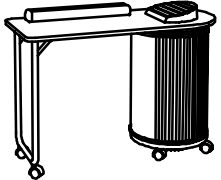
<p>PRISMA, ROUNDAABOUT</p> 	<p>Prisma Manicure Table Center Drawer</p> 	<p>Prisma Manicure Table Closed Storage End</p> 	<p>Prisma Manicure Table Stepped End</p> 	<p>Prisma Manicure Table Tiered End</p> 	<p>Roundabout Manicure Table</p> 	
Order	PZ102-DW		PZ102-CS	PZ102-ST	PZ102-TR	RB02
List Price	Grade 1	Grade 2				See colors below
<p>With vent PZ102-DWV-MX With vent RB02-V With lamp 1058 add: Charcoal filter RB02-FL add:</p>	\$342	\$391	\$451	\$316	\$282	\$438
	\$818	\$867				\$643
	\$57					\$39
Specifications						
Shipping weight (lbs.)	40		42	36	34	22
Width (in.)	31 ³ / ₄		12	3 ⁹ / ₁₆	2 ¹ / ₄	44
Depth (in.)	18		18	18	18	19
Height (in.)	5 ¹ / ₂		30 ³ / ₄	30 ³ / ₄	30 ³ / ₄	29 ¹ / ₄
Specify colors	1. Main. Armrest pad.		Laminate	Laminate	Laminate	Roundabout: black. Top: white or fog, Polish tray black.
Features	Unfinished ends. One drawer. Lamp socket. Specify client armrest 3Z400025.		Use with PZ102-DW. Full width door. One adjustable shelf. Two casters.	Use with PZ102-DW. Two casters	Use with PZ102-DW. Two casters	Durable molded plastic construction. Chrome steel leg. Lockable grooved door with five trays. Upholstered armrest pad. For vented model, order RB02V: Same as RB02 and with vented top.

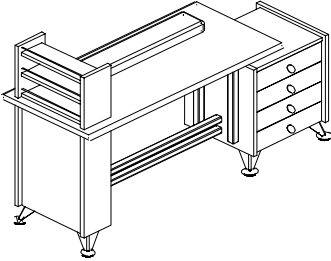
<p>PROFILE</p>	<p style="text-align: center;">Manicure</p> 
<p>Model</p>	<p>PR02</p>
<p>List Price</p>	<p>\$2,137</p>
<p>Specifications</p> <p>Width (in.), footprint</p> <p>Depth (in.), footprint</p> <p>Height (in.),</p>	<p>56</p> <p>20</p> <p>41</p>
<p>Specify Colors</p>	<p>1. Main.</p> <p>2. Top</p> <p>Armrest pad, 3Z400025</p>
<p>Features</p>	<p>Tapered, ball foot legs with matte nickel finish. Decorative slant knobs with matte nickel finish. Four drawer storage cabinet. Open upper display shelves. Upholstered nail pad. Radius edge on both sides of worktop.</p>

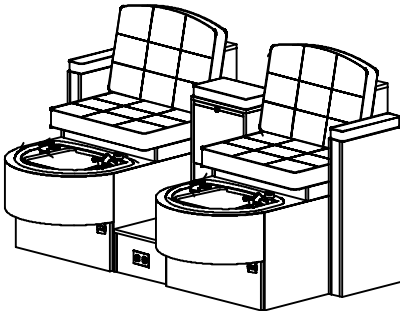
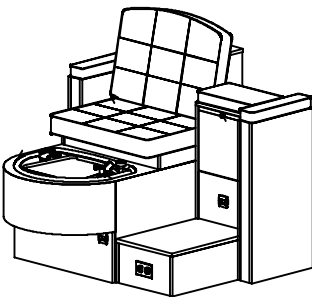
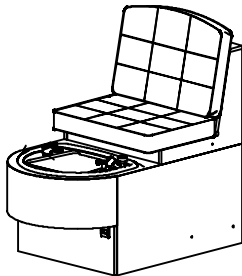
<h1>ALEXANDRIA</h1> <p>UL and CUL listed ANSI/ASME approved Conformance to local codes is the responsibility of the purchaser.</p>	<p>Double Pedicare</p> 		<p>Single Pedicare</p> 		<p>Additional Unit</p> 	
<p>Order</p>	AL02A Grade 1	Grade 2	AL01A Grade 1	Grade 2	AL03A Grade 1	Grade 2
<p>List Price</p>	\$7,846	\$8,146	\$4,948	\$5,098	\$3,656	\$3,806
<p>w/heat and massage</p>	AL02AHM \$9,884	\$10,184	AL01AHM \$6,024	\$6,174	AL03AHM \$4,491	\$4,641
<p>Options: 528 fixture add:</p>	\$198		\$99		\$99	
<p>Specifications Shipping weight (lbs.) Width (in.) Depth (in.) Height (in.)</p>	752 80 ¹ / ₂ 47 ¹⁵ / ₁₆ - 51 ¹⁵ / ₁₆ 47 ¹¹ / ₁₆		434 52 ¹ / ₄ 47 ¹⁵ / ₁₆ - 51 ¹⁵ / ₁₆ 41 ¹¹ / ₁₆		318 28 ¹ / ₄ 47 ¹⁵ / ₁₆ - 51 ¹⁵ / ₁₆ 41 ¹¹ / ₁₆	
<p>Specify Laminate, fabric and enamel colors</p>	<p>1. Laminate: cabinet 2. Vinyl: chair and arm pad. 3. Enamel: bowl</p> <p>Black foot pad.</p>		<p>1. Laminate: cabinet 2. Vinyl: chair and arm pad. 3. Enamel: bowl</p> <p>Black foot pad.</p>		<p>1. Laminate: cabinet 2. Vinyl: chair 3. Enamel: bowl</p> <p>Black foot pad.</p>	
<p>Features</p>	<p>Custom designed enameled bowl with self-rim and recessed fixture deck. Seat: 14¹/₂ inches front-to-back, 16 inches wide, 7¹/₂ inches deep. Three seat positions are available. The selected position is locked in place at insulation. Dual water jets. 522 or 528 fixture with Whiz® spray and 603 backflow preventer. Pre-plumbed with connections ready for installation. Gravity drain. Electrical and plumbing requirements: 120V, 60Hz., 5.5 amps Waste: 1¹/₂ PVC Incoming water: 1/2 NPT</p>		<p>Custom designed enameled bowl with self-rim and recessed fixture deck. Seat: 14¹/₂ inches front-to-back, 16 inches wide, 7¹/₂ inches deep. Three seat positions are available. The selected position is locked in place at insulation. Dual water jets. 522 or 528 fixture with Whiz® spray and 603 backflow preventer. Pre-plumbed with connections ready for installation. Gravity drain. Electrical and plumbing requirements: 120V, 60Hz., 5.5 amps Waste: 1¹/₂ PVC Incoming water: 1/2 NPT</p>		<p>Custom designed enameled bowl with self-rim and recessed fixture deck. Seat: 14¹/₂ inches front-to-back, 16 inches wide, 7¹/₂ inches deep. Three seat positions are available. The selected position is locked in place at installation. Dual water jets. 522 or 528 fixture with Whiz® spray and 603 backflow preventer. Pre-plumbed with connections ready for installation. Gravity drain. Electrical and plumbing requirements: 120V, 60Hz., 5.5 amps Waste: 1¹/₂ PVC Incoming water: 1/2 NPT</p>	

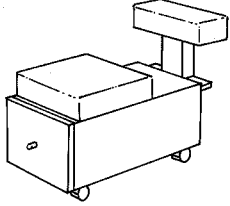
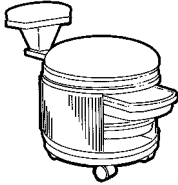
CASCADE, ROUNDAABOUT	Cascade Pedicart 	Roundabout Pedicart 				
Order	CS03A	RB03-BL				
List Price	<table border="1"> <tr> <td>Grade 1</td> <td>Grade 2</td> </tr> <tr> <td>\$373</td> <td>\$470</td> </tr> </table>	Grade 1	Grade 2	\$373	\$470	\$259
Grade 1	Grade 2					
\$373	\$470					
Specifications						
Shipping weight (lbs.)	38	15				
Width (in.)	12 ⁵ / ₁₆	17				
Depth (in.)	27	22				
Height (in.)	19 ³ / ₄	21				
Specify colors	Laminate Vinyl fabric	Black only				
Features	Upholstered seat and footrest. Footrest extends 10 inches. Dual casters.	Durable molded plastic construction. Padded upholstered seat and footrest. Seat: 17" dia. x 17" high. Grooved door. Two trays 14 ¹ / ₄ " long x 9" wide.				

<p>CLEOPATRA</p> <p>UL and CUL listed ANSI/ASME approved Conformance to local codes is the responsibility of the purchaser.</p> <p>Order quantity and model number as indicated for each unit.</p>	<p style="text-align: center;">Cleopatra Pedicare</p>	<p style="text-align: center;">Step for Cleopatra or Victoria Pedicare</p>								
<p>Order Model Number</p>	<p>1, CP22GCAB-(Specify color. See colors below) 1, CP22BCHR</p>	<p>SP24</p>								
<p>List Price</p>	<table border="1" style="width: 100%; text-align: center;"> <tr> <td>Grade 1</td> <td>Grade 2</td> </tr> <tr> <td>\$5,758</td> <td>\$5,908</td> </tr> </table>	Grade 1	Grade 2	\$5,758	\$5,908	<p>\$421</p>				
Grade 1	Grade 2									
\$5,758	\$5,908									
<p>Options 528 fixture add: \$100</p>										
<p>Specifications Shipping weight (lbs.) Width (in.) Depth (in.) Height (in.)</p>	<table border="1" style="width: 100%; text-align: center;"> <tr> <td>275</td> </tr> <tr> <td>31¹/₄</td> </tr> <tr> <td>67³/₁₆</td> </tr> <tr> <td>51¹/₄</td> </tr> </table>	275	31 ¹ / ₄	67 ³ / ₁₆	51 ¹ / ₄	<table border="1" style="width: 100%; text-align: center;"> <tr> <td>20</td> </tr> <tr> <td>10</td> </tr> <tr> <td>33</td> </tr> <tr> <td>8</td> </tr> </table>	20	10	33	8
275										
31 ¹ / ₄										
67 ³ / ₁₆										
51 ¹ / ₄										
20										
10										
33										
8										
<p>Specify colors</p>	<ol style="list-style-type: none"> 1. Laminate: lower cabinet 2. Enamel: bowl 3. ABS top and tube color: Black, -BL, Fog, -FG, White, -WH, or Beige, -BG. 4. Vinyl: chair 	<p>Laminate</p>								
<p>Features</p>	<p>Chair moves up and back in one movement. Height adjustment 4¹/₂ inches, Front-to-back adjustment 2¹/₂ inches. Electric handheld control. Relaxor™ heat and massage with handheld control for client control of speed, intensity and massage: one area or shoulder to thighs. Chair swivels 90 degrees from center -right and left. Custom designed enameled bowl with recessed fixture deck and self-rim. Bowl size 14¹/₂ inches front-to-back, 16 inches wide, 7¹/₂ inches deep. Dual water jets. 522 or 528 fixture with Whiz® spray and 603 backflow preventer. Pre-plumbed with connections ready for installation. Gravity drain. Filler panel included. 120 volt, 60Hz, 5.5 amps</p> <p>Minimum clearance from back wall 12 inches if back filler panel not used.</p> <p>Minimum clearance from side wall 13 inches.</p>	<p>Half-circle step used with CP22G or VC22G.</p>								

Price List USA
Effective January 1, 2007

belvedere

WELLNESS COLLECTION

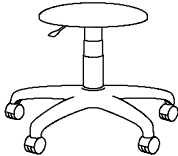
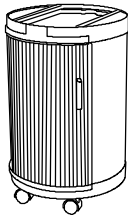
<p>MIRAGE® 500</p> <p>Conformance to local codes is the responsibility of the purchaser. Agency approvals pending.</p>			
<p>Model number Model name/description</p>	<p>MPS500 Mirage™ Pedicare</p>	<p>ST68 Tech Chair</p>	<p>RB05-B2 Peditrolley</p>
<p>List Price</p>	<p>\$6,077</p>	<p>\$314</p>	<p>\$321</p>
<p>Options:</p> <p>Fresh™ (Case of 12) 20015500</p> <p>Fresh™ (4 qt. spray kit) 20015542</p> <p>Sanitation System</p>	<p>\$235</p> <p>\$117</p> <p>\$855</p>		
<p>Specifications</p> <p>Shipping weight (lbs.)</p> <p>Width (in.)</p> <p>Depth (in.)</p> <p>Height (in.)</p>	<p>420</p> <p>35³/₄</p> <p>87</p> <p>55¹¹/₁₆</p>	<p>25</p> <p>18¹/₄</p> <p>-</p> <p>18</p>	<p>13</p> <p>17</p> <p>-</p> <p>28</p>
<p>Specify fabric*, armrest, shroud and enamel* colors</p> <p>*Additional lead time of three weeks when ordered in any non-standard Mirage™ enamel color or Mirage™ Levante™ fabric color other than those listed.</p>	<p>Standard Levante™ Fabric:</p> <p>MF728 Black</p> <p>MF737 Flint Gray</p> <p>MF738 Haze Gray</p> <p>MF739 Buff</p> <p>MF740 Mushroom</p> <p>MF741 Hemlock</p> <p>MF742 Russet</p> <p>Standard Enamel:</p> <p>PE728 Soft Black</p> <p>PE040 Deep Gray</p> <p>PE524 Platinum</p> <p>PE708 Buff</p> <p>PE018 Beige</p> <p>PE733 White</p> <p>Shroud:</p> <p>PM306 Black</p> <p>PM309 Dark Gray</p> <p>PM308 Light Gray</p> <p>PM307 Buff Monterey</p>	<p>Standard Levante™ Fabric:</p> <p>MF728 Black</p> <p>MF737 Flint Gray</p> <p>MF738 Haze Gray</p> <p>MF739 Buff</p> <p>MF740 Mushroom</p> <p>MF741 Hemlock</p> <p>MF742 Russet</p>	<p>Black only.</p>
<p>Features</p>	<p>Dual jet, porcelain enamel foot bowl; steel frame shrouded in Kydex®; upholstered armrest; padded and upholstered seat and back; chair moves forward/back; chair turns to either side for easy access; requires 15 amp dedicated circuit with ground fault interrupter; electrical: 120V, 60Hz., 3 amp.; outgoing water: 1¹/₄ inch PVC; incoming water: 1¹/₂ inch NPT; All plumbing is routed through back of unit; plumbing installation can be in wall or in floor.</p>	<p>Pneumatic height adjustment, telescoping cover on pneumatic cylinder, black base, dual wheel casters.</p>	<p>Molded plastic construction, lockable grooved door with five trays.</p>



WATER SUPPLY GUIDELINES

Note: Water requirements may vary according to usage. Consult your plumbing contractor.

Chart A: For Mirage Pedicare Only (NOT including shampoo bowls, wash rooms, vichy showers, etc.):

No. of Units	Supply Line Size	Water Heater Capacity	Recovery Rate (Gal. Per Hr.)
1-2	3/4"	50 Gal.	100
3	1"	75 Gal	150
4	1 to 1-1/4"	100 Gal	200

More than 4 units: minimum 50 gallons capacity for every two Mirage units.

Chart B: For hair styling salons with shampoo bowls PLUS one Mirage Pedicare:

No. of Bowls Plus One Mirage	Supply Line Size	Water Heater Capacity	Recovery Rate (Gal. Per Hr.)
1-2	3/4"	75 Gal..	150
3-5	1"	100 Gal.	200

6 or more shampoo bowls: Install a separate water heater for the Mirage Pedicare stations per Chart A.

NOTE: MUST use rapid recovery water heater.

ALL plumbing MUST conform to local codes.

Any conformance with LOCAL CODES or INSPECTIONS is the RESPONSIBILITY OF THE PURCHASER.

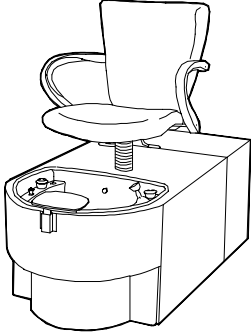
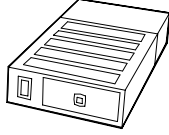
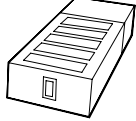
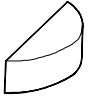
<p>VICTORIA</p> <p>UL and CUL listed ANSI/ASME approved</p> <p>Conformance to local codes is the responsibility of the purchaser.</p>	<p>Victoria Pedicare shown with Caddy chair top</p> 	<p>Step with drawer and electrical outlet</p> 	<p>Step with electrical outlet</p> 	<p>Step Half-Circle</p> 																																				
<p>Order</p>	<p>1 VC22GCAB 1 VC21P</p>	<p>SP22C</p>	<p>SP23C</p>	<p>SP24</p>																																				
<p>List Price</p> <p>AH22 AH22C Arch DD12 Caddy (shown) BD82 Delta HP12 Hampton H82CS Hound KT12 Kallista RV 12 Riva 2000 S92S Scroll D42T Tara V32CS Vixen</p>	<table border="1"> <thead> <tr> <th></th> <th>Grade 1</th> <th>Grade 2</th> </tr> </thead> <tbody> <tr> <td></td> <td>\$3,729</td> <td>\$3,829</td> </tr> <tr> <td></td> <td>\$3,729</td> <td>\$3,829</td> </tr> <tr> <td></td> <td>\$3,821</td> <td>\$3,921</td> </tr> <tr> <td></td> <td>\$3,729</td> <td>\$3,829</td> </tr> <tr> <td></td> <td>\$3,677</td> <td>\$3,777</td> </tr> <tr> <td></td> <td>\$3,579</td> <td>\$3,679</td> </tr> <tr> <td></td> <td>\$3,858</td> <td>\$3,958</td> </tr> <tr> <td></td> <td>\$3,761</td> <td>\$3,861</td> </tr> <tr> <td></td> <td>\$3,868</td> <td>\$3,968</td> </tr> <tr> <td></td> <td>\$3,761</td> <td>\$3,861</td> </tr> <tr> <td></td> <td>\$3,578</td> <td>\$3,678</td> </tr> </tbody> </table>		Grade 1	Grade 2		\$3,729	\$3,829		\$3,729	\$3,829		\$3,821	\$3,921		\$3,729	\$3,829		\$3,677	\$3,777		\$3,579	\$3,679		\$3,858	\$3,958		\$3,761	\$3,861		\$3,868	\$3,968		\$3,761	\$3,861		\$3,578	\$3,678	<p>\$792</p>	<p>\$601</p>	<p>\$421</p>
	Grade 1	Grade 2																																						
	\$3,729	\$3,829																																						
	\$3,729	\$3,829																																						
	\$3,821	\$3,921																																						
	\$3,729	\$3,829																																						
	\$3,677	\$3,777																																						
	\$3,579	\$3,679																																						
	\$3,858	\$3,958																																						
	\$3,761	\$3,861																																						
	\$3,868	\$3,968																																						
	\$3,761	\$3,861																																						
	\$3,578	\$3,678																																						
<p>Options: 528 fixture add: \$96</p>																																								
<p>Specifications</p> <p>Shipping weight (lbs.) Width (in.) Depth (in.) Height (in.)</p>	<p>315 28¹/₄ 56⁷/₈ 42</p>	<p>60 23²⁵/₁₆ 33¹/₄ 8</p>	<p>40 15¹/₁₆ 33¹/₄ 8</p>	<p>20 10 33 8</p>																																				
<p>Specify Laminate, fabric and enamel colors</p>	<p>1. Laminate: lower cabinet 2. Enamel: bowl 3. Vinyl: chair and footpad.</p>	<p>Main</p>	<p>Main</p>	<p>Main</p>																																				
<p>Features</p>	<p>Custom designed enameled bowl with self-rim and recessed fixture deck. 14¹/₂ inches front-to-back, 16 inches wide, 7¹/₂ inches deep. Dual water jets. 522 or 528 fixture with Whiz® spray and 603 backflow preventer. Pre-plumbed with connections ready for installation. Gravity drain. Filler panel included. Electrical requirements: 120V, 60Hz, 5.5 amps</p> <p>Minimum clearance from back wall 12 inches if back filler panel is not used from side wall 13 inches.</p>	<p>Use with VC22C Victoria pedicare. GFI duplex outlet. Hardwire on site. Storage drawer. Can be used either right or left side of pedicare. 12" Filler panel. Specify laminate.</p>	<p>Use with VC22C Victoria pedicare. GFI duplex outlet. Hardwire on site. Can be used either right or left side of pedicare. 12" Filler panel. Specify laminate.</p>	<p>Use with VC22C Victoria pedicare. Can be used either right or left side of pedicare. Specify laminate.</p>																																				