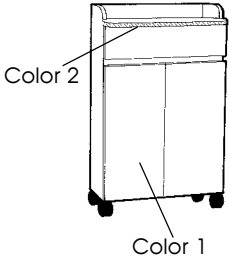
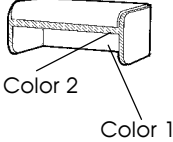
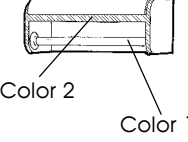
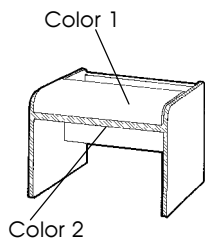
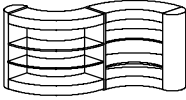
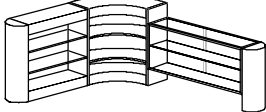
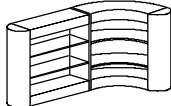
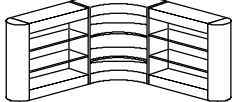
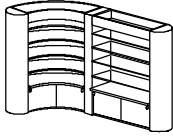
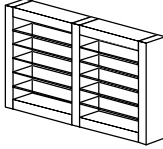
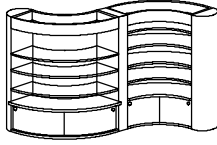
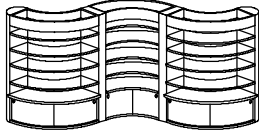

<h1>RECEPTION</h1>	<b>Coffee Bar</b> 	<b>Shelf</b> 	<b>Coat Rack</b> 	<b>Magazine Table</b> 
<b>Model</b>	1639QA	1640QA	1648QA	1649QA
<b>List Price</b>	\$1,261	\$522	\$533	\$673
<b>Specifications</b> Shipping weight (lbs.) Width (in.) Depth (in.) Height (in.)	104 21 <sup>7</sup> / <sub>8</sub> 15 <sup>1</sup> / <sub>4</sub> 38	18 23 <sup>1</sup> / <sub>4</sub> 14 <sup>3</sup> / <sub>4</sub> 9 <sup>5</sup> / <sub>8</sub>	19 23 <sup>1</sup> / <sub>4</sub> 14 <sup>3</sup> / <sub>4</sub> 9 <sup>5</sup> / <sub>8</sub>	38 24 29 18
<b>Specify colors:</b>	1. Main. 2. Edging on front.	1. Main. 2. Edging on end panels and on front.	1. Main. 2. Edging on front and end panels.	1. Main. 2. Edging on front and end panels.
<b>Features</b>	One drawer with two dividers. Lower storage with adjustable shelf. Finger pulls on doors. Casters.	Use with 1639 Coffee Bar. Mounts to wall with a French cleat.	Mounts to wall with a French cleat.	Two slots in back to hold magazines.

<p><b>ARRAY</b></p> <p>Order quantity and model number indicated.</p>	<p><b>Two Displays</b></p> 	<p><b>Two Displays and One Showcase</b></p> 	<p><b>Two Displays</b></p> 	<p><b>Three Displays</b></p> 
<p><b>Order</b></p>	<p>2, AY48-CE 2, AY48-R 1, AY48-FC 2, AYGL-2R</p>	<p>1, AY48-CE 1, AY36-CE 1, AY48-R 1, AY48-FE 1, AY48-S 1, AY48-FC 1, AYSC 1, AYGL-2S 1, AYGL-2R</p>	<p>2, AY48-CE 1, AY48-S 1, AY48-R 1, AY48-FC 1, AYGL-2S 1, AYGL-2R</p>	<p>2, AY48-CE 2, AY48-S 1, AY48-R 2, AY48-FC 2, AYGL-2S 1, AYGL-2R</p>
<p><b>List Price</b></p>	<p>\$4,286</p>	<p>\$6,487</p>	<p>\$3,671</p>	<p>\$4,471</p>
<p><b>Specifications</b></p> <p>Width (in.)</p> <p>Depth (in.)</p> <p>Height (in.)</p>	<p>82<sup>1</sup>/<sub>2</sub></p> <p>27<sup>1</sup>/<sub>2</sub></p> <p>48</p>	<p>75<sup>1</sup>/<sub>4</sub></p> <p>93<sup>3</sup>/<sub>4</sub></p> <p>36-48</p>	<p>75<sup>1</sup>/<sub>4</sub></p> <p>38</p> <p>48</p>	<p>75<sup>1</sup>/<sub>4</sub></p> <p>75<sup>1</sup>/<sub>4</sub></p> <p>48</p>
<p><b>Specify colors:</b></p>	<p>See individual components for color location.</p>	<p>See individual components for color location.</p>	<p>See individual components for color location.</p>	<p>See individual components for color location.</p>
<p><b>Features</b></p>	<p>Two curved ends AY48-CE, two radius cabinets AY48-R, one flat center AY48-FC, two glass shelves AYGL-2R.</p>	<p>One curved end AY48-CE, one curved end AY36-CE, one straight cabinet AY48-S, one radius cabinet AY48-R, one flat center AY48-FC, one flat end AY48-FE, one straight glass shelves, AYGL-2S, one radius glass shelves AYGL-2R. AYSC 54 inch show case, display light, sliding glass door, clear finger pull.</p>	<p>Two curved ends AY48-CE, one straight cabinet AY48-S, one radius cabinet AY48-R, one flat center AY48-FC, one straight glass shelves AYGL-2S, one radius glass shelves AYGL-2R.</p>	<p>Two curved ends AY48-CE, two straight cabinets AY48-S, one radius cabinet AY48-R, two flat centers, AY48-FC, two straight glass shelves AYGL-2S, one radius glass shelves AYGL-2R,</p>

<p><b>ARRAY</b></p> <p>Order quantity and model number indicated.</p>	<p>Two Displays</p> 	<p>Two Straight Displays</p> 	<p>Two Display Cabinets</p> 	<p>Three Display Cabinets</p> 
<p><b>Order</b></p>	<p>2, AY84CE 1, AY84-IRD or AY84-IRD-LT 1, AY84-SD or AY84-SD-LT 1, AY84-SC 1, AYGL-5R 1, AYGL-5S</p>	<p>2, AY84-SE 2, AY84-S or AY84-S-LT 1, AY84-SC 2, AYGL-5S</p>	<p>2, AY84-CE 1, AY84-ORD or AY84-ORD-LT 1, AY84-IRD or AY84-IRD-LT 1, AY84-SC 2, AYGL-4R</p>	<p>2, AY84-CE 2, AY84-ORD or AY84-ORD-LT 1, AY84-IRD or AY84-IRD-LT 2, AY84-SC 3, AYGL-4R</p>
<p><b>List Price</b></p> <p>Without lights</p> <p>With lights</p>	<p>\$6,549</p> <p>\$6,815</p>	<p>\$4,050</p> <p>\$4,314</p>	<p>\$7,676</p> <p>\$7,942</p>	<p>\$10,829</p> <p>\$11,829</p>
<p><b>Specifications</b></p> <p>Width (in.)</p> <p>Depth (in.)</p> <p>Height (in.)</p>	<p>75<sup>1</sup>/<sub>2</sub></p> <p>37<sup>1</sup>/<sub>2</sub></p> <p>84</p>	<p>93</p> <p>14</p> <p>84</p>	<p>87<sup>1</sup>/<sub>4</sub></p> <p>34<sup>3</sup>/<sub>4</sub></p> <p>84</p>	<p>129<sup>1</sup>/<sub>2</sub></p> <p>34<sup>3</sup>/<sub>4</sub></p> <p>84</p>
<p><b>Specify colors:</b></p>	<p>See individual components for color location.</p>	<p>See individual components for color location.</p>	<p>See individual components for color location.</p>	<p>See individual components for color location.</p>
<p><b>Features</b></p>	<p>Two curved ends AY84-CE, one radius cabinet AY84-IRD or with light AY84-IRD-LT, one straight cabinet AY84-SD or with light AY84-SD-LT, one straight center AY84-SC, one radius glass shelves AYGL-5R., one straight glass shelves AYGL-5S. Hardwire on site.</p>	<p>Two square ends AY84-SE, two straight cabinets AY84-S or with light AY84-S-LT, one straight center AY84-SC, two glass shelves AYGL-5S. Hardwire on site.</p>	<p>Two curved ends AY84-CE, one outside radius cabinets with storage AY84-ORD or one outside radius cabinets with storage and light AY84-ORD-LT, one inside radius cabinets with storage AY84-IRD or one inside radius cabinets with storage and light AY84-IRD-LT, one straight center AY84-SC, two glass shelves ATGL-4R. Hardwire on site.</p>	<p>Two curved ends AY84-CE, two outside radius cabinets with storage AY84-ORD or two outside radius cabinets with storage and lights AY84-ORD-LT, one inside radius cabinet with storage AY84-IRD or one inside radius cabinet with storage and light AY84-IRD-LT, two straight centers AY84-SC, three glass shelves AYGL-4R. Hardwire on site.</p>

<b>ARRAY</b>	<b>End</b>	<b>End</b>	<b>End</b>	<b>End</b>	<b>Center</b>	<b>End</b>	<b>Radius Display</b>
<b>Model</b>	AY36-CE	AY36-FE	AY36-SE	AY48-CE	AY48-FC	AY48-FE	AY48-R
<b>List Price</b>	\$781	\$176	\$566	\$827	\$198	\$198	\$822
<b>Specifications</b>							
Width (in.)	14	14	14	14	14	14	42 <sup>3</sup> / <sub>4</sub>
Depth (in.)	7	13 <sup>3</sup> / <sub>16</sub>	7	7	13 <sup>3</sup> / <sub>16</sub>	13 <sup>3</sup> / <sub>16</sub>	17 <sup>3</sup> / <sub>4</sub>
Height (in.)	36	36	36	48	48	48	48
<b>Specify Colors</b>	1. Main	1. Main	1. Main	1. Exterior 2. Interior	1. Edging 2. Interior	1. Edging 2. Interior	1. Main
<b>Features</b>	Showcase radius end column 36 inches.	Showcase flat end column 36 inches.	Showcase square end column 36 inches.	Curved end.	Flat center.	Flat end.	Radius display. 48 inches.

<b>Array</b>	<b>Straight Display</b>	<b>Center</b>	<b>End</b>	
<b>Model</b>	AY48-S	AY48-SC	AY48-SE	AYSC
<b>List Price</b>	\$422	\$659	\$595	\$2,664
<b>Specifications</b>				
Width (in.)	36	14	14	54
Depth (in.)	12 <sup>1</sup> / <sub>2</sub>	7	7	12 <sup>1</sup> / <sub>8</sub>
Height (in.)	48	48	48	28
<b>Specify Colors</b>	1. Main	1. Exterior 2. Interior	1. Exterior 2. Interior	1. Main
<b>Features</b>	Straight display. 48 inches.	Square Center. 48 inches.	Square end. 48 inches.	Showcase. 54 inches.

	End	Center	End	Radius Display Inside Radius	Radius Display Outside Radius	Straight Display
<b>ARRAY</b> with storage						
<b>Order</b>	AY84-CE	AY84-FC	AY84-FE	AY84-IRD	AY84-ORD	AY84-SD
<b>List Price no light</b>	\$1,071	\$237	\$237	\$1,399	\$1,399	\$809
<b>Order with light</b>				AY84-IRD-LT	AY84-ORD-LT	AY84-SD-LT
<b>List Price with light</b>				\$1,532	\$1,532	\$942
<b>Specifications</b>						
Width (in.)	14	14	14	43	48	36
Depth (in.)	7	1 3/16	1 3/16	20 1/8	21 1/4	16
Height (in.)	84	84	84	84	84	84
<b>Specify Colors</b>	1. Exterior 2. Interior	1. Edging 2. Interior	1. Outside and Edging 2. Interior	1. Main 2. Top of storage cabinet. 3. Edging on storage cabinet	1. Main 2. Top of storage cabinet. 3. Edging on storage cabinet	1. Main 2. Top of lower cabinet. 3. Edging on lower cabinet.
<b>Features</b>	Curved end.	Flat center.	Flat end.	Inside radius display. Optional light in upper display.	Outside radius display. Optional light in upper display.	Straight display with storage. Optional light in upper display.

	Straight Display	Center	Radius Display Outside or Inside	End
<b>Array</b> without storage				
<b>Order no light</b>	AY84-S	AY84-SC	AY84-R	AY84-SE
<b>List Price</b>	\$422	\$772	\$822	\$772
<b>Order with light</b>	AY84-S-LT		AY84-R-LT	
<b>List Price</b>	\$554		\$955	
<b>Specifications</b>				
Width (in.)	36	14	42 3/4	14
Depth (in.)	12 1/2	7	17 3/4	7
Height (in.)	84	84	84	84
<b>Specify Colors</b>	1. Main	1. Exterior 2. Interior	1. Main	1. Exterior 2. Interior
<b>Features</b>	<b>Must use AY84-SC and AY84-SE.</b> Straight display. Optional light in upper display.	Square center.	<b>Must use AY84-SC and AT84-SE</b> Radius display. May be used as inside or out-side radius. Optional light in upper display.	Square end.

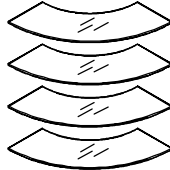
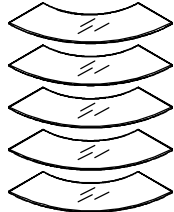
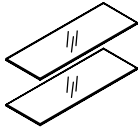
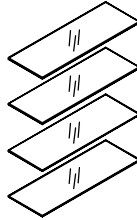
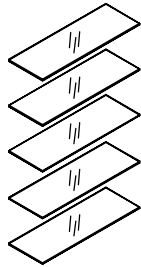
<b>ARRAY</b>	<b>Radius Glass shelves Set of 2</b>	<b>Radius Glass shelves Set of 4</b>	<b>Radius Glass shelves Set of 5</b>	
				
	<b>Model</b>	AYGL-2R	AYGL-4R	AYGL-5R
	<b>List Price</b>	\$395	\$785	\$982
	<b>Specifications</b>			
	Width (in.) Depth (in.) Thickness (in.)	29 7/8 29 7/8 3/8	29 7/8 29 7/8 3/8	29 7/8 29 7/8 3/8
<b>Features</b>	Use with AY48-R	Use with AY48-ORD, AY48-ORD-LT and with AY48-IRD OR AY48-IRD-LT.	Use with AY84-R OR AY84-R-LT	
<b>Array</b>	<b>Straight Glass shelves Set of 2</b>	<b>Straight Glass shelves Set of 4</b>	<b>Straight Glass shelves Set of 5</b>	
				
	<b>Model</b>	AYGL-2S	AYGL-4S	AYGL-5S
	<b>List Price Display</b>	\$180	\$357	\$445
	<b>Specifications</b>			
	Width (in.) Depth (in.) Thickness (in.)	35 3/4 12 3/8	35 3/4 12 3/8	35 3/4 12 3/8
<b>Features</b>	Use with AY48-S	Use with AY84-SD or AY84-SD-LT	Use with AY84-S.	

**BOSTONIAN**

All models  
color 1: Main-  
doors, kicks, soffits,  
front and end  
edges.

BT182L-LT  
Left-hand display

BT184-30-LT  
Inner display

BT183C-36-LT  
Center curved  
display

BT184-30-LT  
Inner display

BT182R-LT  
Right-hand display

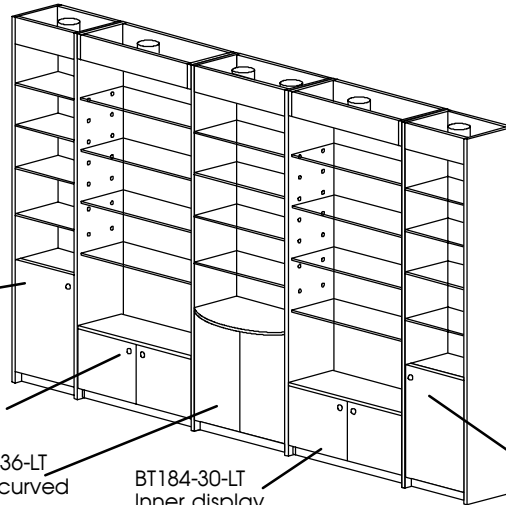

**Order**

1, BT182L-LT (left-hand cabinet)  
1, BT183C-36-LT (center curved display cabinet)  
2, BT184-30-LT (inner display cabinet)  
1, BT182R-LT (right-hand cabinet)

List Price

\$7,306

Option:

Mirrored backs

BT183-24-M10 add:

\$182

BT184-30-M10 add:

\$232

BT182-M10 add:

\$129

**Specifications**

Width (in.), footprint

126<sup>1</sup>/<sub>4</sub>

Depth (in.), footprint

20

Height (in.),

90

**Specify Color**

1. Main: Doors, kicks, soffits, front and end edges.
2. Trim: Worktops and edges.
3. Trim: Interior surfaces.

**Features**

For mirrored back on BT183L-24-LT left-hand cabinet order BT183-24-M10, for BT184-30-LT center cabinet order BT184-30-M10, and for BT182R-LT right-hand cabinet order BT182-M10.

All lights are ready to plug in.

Consists of:

- 1 Left-hand tower display BT182L-LT has four glass shelves, two adjustable shelves in storage compartment, and one light in soffit.
- 1 Left-hand curved display BT183L-24-LT with four glass shelves, two adjustable shelves in storage compartment, and one light in soffit.
- 2 Inner display BT184-30-LT which must be secured to adjacent Bostonian displays. Four glass shelves, one adjustable shelf in storage compartment, and two lights in soffit.
- 1 Right-hand tower display BT182R-LT has four glass shelves, two adjustable shelves in storage compartment, and one light in soffit.

**NOTE:** Bostonian tower and curved units have predrilled holes on the outside ends for shelf pins to support glass shelves. These inner display units cannot be freestanding.

<b>BOSTONIAN</b>	<b>Center Tower holes drilled both sides Display</b>	<b>Left-hand Finished Tower Display</b>	<b>Right-hand Finished Tower Display</b>	<b>Single Tower Finished both sides Display</b>
<b>Model</b>	BT182C-LT	BT182L-LT	BT182R-LT	BT182S-LT
<b>List Price - One light</b>	\$1,184	\$1,178	\$1,178	\$1,171
Option:				
Mirrored back BT182-M10 add:	\$129	\$129	\$129	\$129
<b>Specifications</b>				
Shipping weight	154	154	154	154
Width (in.)	15 <sup>1</sup> / <sub>8</sub>	15 <sup>1</sup> / <sub>8</sub>	15 <sup>1</sup> / <sub>8</sub>	15 <sup>1</sup> / <sub>8</sub>
Depth (in.)	15 <sup>3</sup> / <sub>4</sub>	15 <sup>3</sup> / <sub>4</sub>	15 <sup>3</sup> / <sub>4</sub>	15 <sup>3</sup> / <sub>4</sub>
Height (in.)	90	90	90	90
<b>Specify colors</b>	1. Main. 2. Trim: (worktop). 3. Interior of display and outside ends.	1. Main. 2. Trim: (worktop). 3. interior of display and right hand outside end.	1. Main. 2. Trim: (worktop). 3. Interior of display and left hand outside end.	1. Main. 2. Trim: (worktop). 3. Interior of display.
<b>Features</b>	Holes on both sides*. Four glass shelves. Two adjustable shelves in storage compartment. Light in soffit. Ready to plug in.	Holes on right side*. Four glass shelves. Two adjustable shelves in storage compartment. Light in soffit. Ready to plug in.	Holes on left side*. Four glass shelves. Two adjustable shelves in storage compartment. Ready to plug in.	May be used as a single unit. Four glass shelves. Two adjustable shelves in storage compartment. Ready to plug in.
<b>NOTE:</b> Bostonian tower and curved units have predrilled holes on the outside ends for shelf pins to support glass shelves. These inner display units cannot be freestanding.				

# BOSTONIAN

**Center Curved Display**

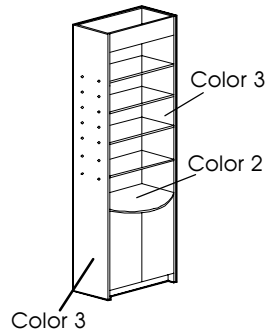

**Left-hand Curved Display**

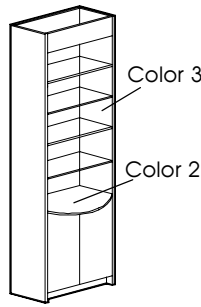

**Right-hand Curved Display**

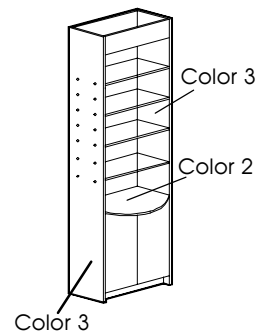

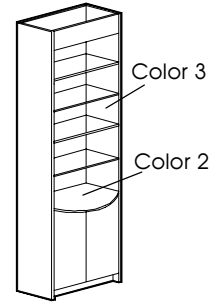

**Single Curved Display**

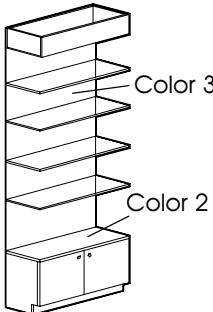
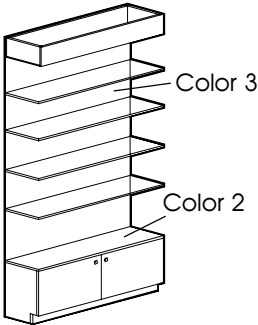

Model	BT183C-24-LT	BT183C-36-LT	BT183L-24-LT	BT183L-36-LT	BT183R-24-LT	BT183R-36-LT	BT183S-24-LT	BT183S-36-LT
<b>List Price - One light</b>	\$1,381	\$1,866	\$1,372	\$1,859	\$1,372	\$1,859	\$1,365	\$1,850
Option: Mirrored Back, BT183-24-M10 add: BT183-36-M10 add:	\$182	\$250	\$182	\$250	\$182	\$250	\$182	\$250
<b>Specifications</b>								
Shipping weight	260	342	260	342	260	342	260	342
Width (in.)	24	36	24	36	24	36	24	36
Depth (in.)	20	20	20	20	20	20	20	20
Height (in.)	90	90	90	90	90	90	90	90
<b>Specify colors</b>	1. Door, kick, soffit, front and end edges. 2. Worktop and edge. 3. Interior surfaces.		1. Door, kick, soffit, front and end edges. 2. Worktop and edge. 3. Interior surfaces.		1. Door, kick, soffit, front and end edges. 2. Worktop and edge. 3. Interior surfaces.		1. Door, kick, soffit, front and end edges. 2. Worktop and edge. 3. Interior surfaces.	
<b>Features</b>	Holes on both sides*. Four glass shelves. Two adjustable shelves in storage compartment. Light in soffit. Ready to plug in.		Holes on right side*. Four glass shelves. Two adjustable shelves in storage compartment. Light in soffit. Ready to plug in.		Holes on left side*. Four glass shelves. Two adjustable shelves in storage compartment. Light in soffit. Ready to plug in.		May be used as a single unit. Four glass shelves. Two adjustable shelves for storage. Light in soffit. Ready to plug in.	
<b>NOTE:</b>	Bostonian tower and curved units have predrilled holes on the outside ends for shelf pins to support glass shelves. These inner display units cannot be freestanding.							

<b>BOSTONIAN</b>	Inner Display	Inner Display
		
<b>Model</b>	BT184-30-LT	BT184-42-LT
<b>List Price - Two lights</b>	\$1,542	\$1,682
Option		
Mirrored back BT184-30-M10 add: BT184-42-M10 add:	\$232	\$301
<b>Specifications</b>		
Shipping weight		211
Width (in.)	30	42
Depth (in.)	12	12
Height (in.)	90	90
<b>Specify colors</b>	<ol style="list-style-type: none"> <li>1. Doors, kick, and soffit front.</li> <li>2. Worktop and edge.</li> <li>3. Back panel and inside surfaces.</li> </ol>	<ol style="list-style-type: none"> <li>1. Doors, kick, and soffit front.</li> <li>2. Worktop and edge.</li> <li>3. Back panel and inside surfaces.</li> </ol>
<b>Features</b>	<p>Open on both sides. Must be secured to adjacent Bostonian displays. Four glass shelves. One adjustable shelf in storage compartment. Light in soffit. Ready to plug in.</p>	<p>Open on both sides. Must be secured to adjacent Bostonian displays. Four glass shelves. One adjustable shelf in storage compartment. Light in soffit. Ready to plug in.</p>
<p><b>NOTE:</b> Bostonian Inner display units cannot be freestanding. Bostonian tower and curved units have predrilled holes. These holes are on the outside ends for shelf pins to support glass shelves.</p>		

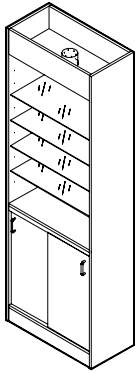
<p><b>JOLIET</b></p>	<p><b>Display</b></p>
<p><b>Model</b></p>	<p>JST36</p>
<p><b>List Price</b></p>	<p>\$2,277</p>
<p><b>Specifications</b> Width (in.) Depth (in.) Height (in.)</p>	<p>36 24 44</p>
<p><b>Specify colors</b></p>	<p>1. Main 2. Top and edges</p>
<p><b>Features</b></p>	<p>Freestanding cabinet with oval frosted glass shelves and six-inch legs.</p>

<h1 style="text-align: center;">JUPITER</h1>	<p style="text-align: center;"><b>Jupiter Display</b></p> 	<p style="text-align: center;"><b>Jupiter Display Finished End</b></p> 
<p><b>Model</b></p>	<p>JP182</p>	<p>JP183</p>
<p><b>List Price</b></p>	<p>\$1,764</p>	<p>\$1,143</p>
<p><b>Specifications</b></p>	<p>Shipping weight (lbs.) 148 Width (in.) 30 Depth (in.) 15 Height (in.) 89<sup>1/2</sup></p>	<p>60 15 7<sup>1/2</sup> 36</p>
<p><b>Specify colors</b></p>	<p>1. Main</p>	<p>1. Main</p>
<p><b>Features</b></p>	<p>Lower storage with 2 adjustable shelves and sliding doors. Upper open display with four 1/4" thick x 28 3/4" wide x 14" deep glass shelves. Black eyeball light in soffit, ready to plug in. Finished four sides.</p>	<p>Finished end. 7 3/4" high soffit and 36" high pedestal. Black eyeball light in soffit, ready to plug in.</p>

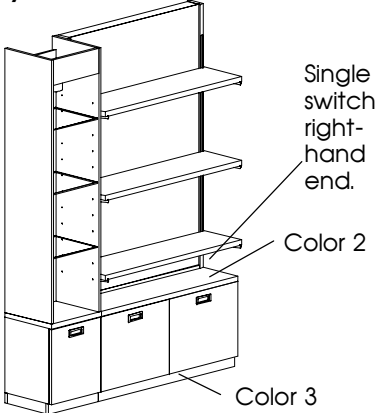
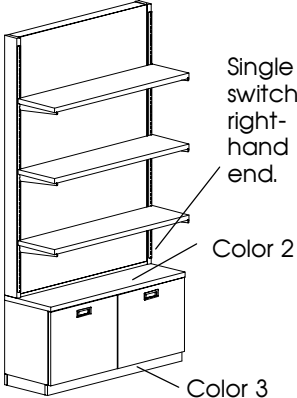
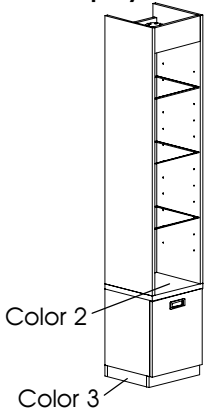
<h1>KALLI</h1>	<p><b>Display</b></p> 	<p><b>Display</b></p> 	<p><b>Display</b></p> 
<p><b>Model</b></p>	<p>KA282 KA283</p>	<p>KA282</p>	<p>KA283</p>
<p><b>List Price</b></p>	<p>\$3,930</p>	<p>\$2,601</p>	<p>\$1,329</p>
<p><b>Specifications</b></p> <p>Width (in.) Depth (in.) Height (in.)</p>	<p>60 16<sup>5</sup>/<sub>16</sub> 83<sup>11</sup>/<sub>16</sub></p>	<p>44 16<sup>5</sup>/<sub>16</sub> 83<sup>11</sup>/<sub>16</sub></p>	<p>16 15<sup>1</sup>/<sub>16</sub> 83<sup>11</sup>/<sub>16</sub></p>
<p><b>Specify colors</b></p>	<p>1. Main. 2. Top of storage. 3. Kick and frame.</p>	<p>1. Main. 2. Top of storage. 3. Kick and frame.</p>	<p>1. Main. 2. Top of storage. 3. Kick.</p>
<p><b>Features</b></p>	<p>Must be secured to wall.</p> <p>Features two drawers, back is frosted plexi-glass with back lights and single switch in the KA182 (right-hand side) and eyeball light, drawer, three adjustable glass shelves. in the KA283. Recessed pulls.</p>	<p>Must be secured to wall.</p> <p>Features two drawers, back is frosted plexi-glass with back lights and single switch on right-hand side. Recessed pulls.</p>	<p>Must be secured to wall.</p> <p>Features eyeball light, drawer, three adjustable glass shelves. Recessed pulls.</p>

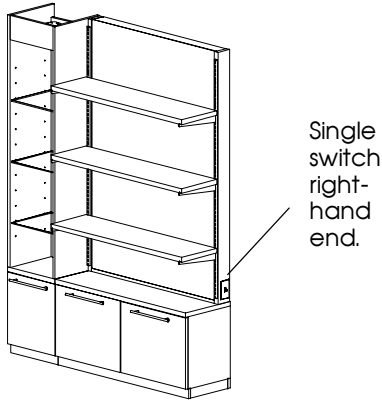
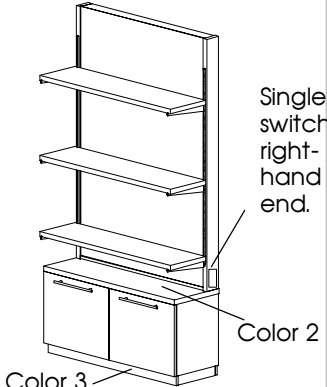
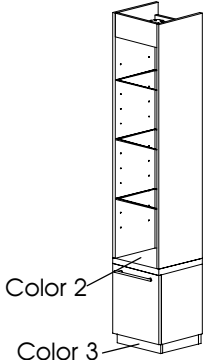
<h1>KALLI</h1>	<p><b>Display</b></p> 	<p><b>Display</b></p> 	<p><b>Display</b></p> 
<p><b>Model</b></p>	<p>KA182 KA183</p>	<p>KA182</p>	<p>KA183</p>
<p><b>List Price</b></p>	<p>\$3,957</p>	<p>\$2,628</p>	<p>\$1,329</p>
<p><b>Specifications</b></p> <p>Width (in.) Depth (in.) Height (in.)</p>	<p>60 16<sup>5</sup>/<sub>16</sub> 83<sup>11</sup>/<sub>16</sub></p>	<p>44 16<sup>5</sup>/<sub>16</sub> 83<sup>11</sup>/<sub>16</sub></p>	<p>16 15<sup>1</sup>/<sub>16</sub> 83<sup>11</sup>/<sub>16</sub></p>
<p><b>Specify colors</b></p>	<p>1. Main 2. Top of storage. 3. Kick and frame.</p>	<p>1. Main 2. Top of storage. 3. Kick and frame.</p>	<p>1. Main 2. Top of storage. 3. Kick.</p>
<p><b>Features</b></p>	<p>Must be secured to wall.</p> <p>Features two drawers, back is frosted plexi-glass with back lights and single switch in the KA182 (right-hand side) and eyeball light, drawer, three adjustable glass shelves. in the KA183. Stainless Steel Pulls.</p>	<p>Must be secured to wall.</p> <p>Features two drawers, back is frosted plexi-glass with back lights and single switch on right-hand side. Stainless Steel Pulls.</p>	<p>Must be secured to wall.</p> <p>Features eyeball light, drawer, three adjustable glass shelves. Stainless Steel Pulls.</p>

**KALLISTA**

**Kallista Display**

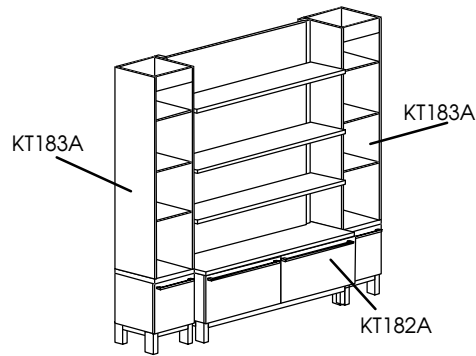

<p><b>Order</b></p>	<p>(1) KT182 (2) KT183</p>
<p><b>List Price</b></p>	<p>\$6,143</p>
<p><b>Specifications</b></p> <p>Width (in.) Depth (in.) Height (in.)</p>	<p>76 15 84</p>
<p><b>Specify colors</b></p>	<ol style="list-style-type: none"> <li>1. Cabinet and shelves.</li> <li>2. Top</li> <li>3. Lefthand drawer face.</li> <li>4. Righthand drawer face.</li> </ol>
<p><b>Features</b></p> <p>All units must be secured to a wall, metal frames finished in soft silver paint, anodized aluminum pulls.</p>	<p>KT182ATF features three fixed laminated shelves, translucent acrylic back with lighting behind, on/off switch on top of cabinet ready to plug in, and two storage drawers. KT183ATF features three adjustable glass shelves in each side unit and one storage drawer. Light in soffit.</p>

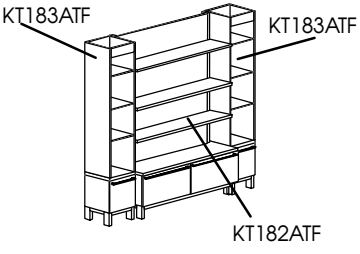
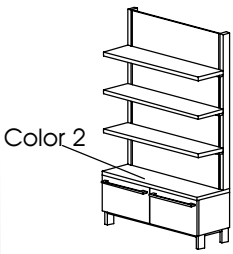
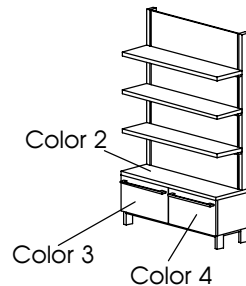
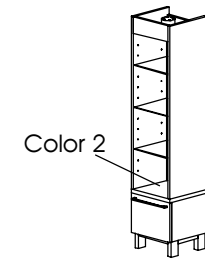
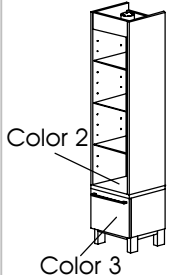
<h1>KALLISTA</h1> 	<p><b>Kallista Display</b></p> 	<p><b>Kallista Display</b></p> 	<p><b>Kallista Display</b></p> 	<p><b>Kallista Display</b></p> 
<p><b>Model</b></p>	KT182	KT182-D	KT183	KT183-D
<p><b>List Price</b></p>	\$3,437	\$3,372	\$1,353	\$1,327
<p><b>Specifications</b></p> <p>Width (in.)</p> <p>Depth (in.)</p> <p>Height (in.)</p>	<p>44</p> <p>15</p> <p>84</p>	<p>44</p> <p>15</p> <p>84</p>	<p>16</p> <p>15</p> <p>84</p>	<p>16</p> <p>15</p> <p>84</p>
<p><b>Specify colors</b></p>	<p>1. Cabinet and shelves.</p> <p>2. Top</p>	<p>1. Cabinet and shelves.</p> <p>2. Top</p> <p>3. Lefthand drawer face.</p> <p>4. Righthand drawer face.</p>	<p>1. Cabinet.</p> <p>2. Top of storage.</p>	<p>1. Cabinet.</p> <p>2. Top of storage.</p> <p>3. Drawer face.</p>
<p><b>Features</b></p>	<p>Must be secured to wall. Metal frames finished in soft silver paint. Anodized aluminum pulls. Three fixed laminated shelves. Translucent acrylic back with lighting behind. On/off switch on top of cabinet ready to plug in. Two storage drawers,</p>	<p>Must be secured to wall. Metal frames finished in soft silver paint. Anodized aluminum pulls. Three fixed laminated shelves. Translucent acrylic back with lighting behind. On/off switch on top of cabinet ready to plug in. Two storage drawers, Drawer faces may be specified as trim colors.</p>	<p>Must be secured to wall. Metal frames finished in soft silver paint. Anodized aluminum pulls. Light in soffit. Three adjustable glass shelves. One storage drawer, May be used individually or as a right-hand or left-hand unit with the KT182ATF or KT182-D.</p>	<p>Must be secured to wall. Metal frame finished in soft silver paint. Anodized aluminum pull. Light in soffit. Three adjustable glass shelves. One storage drawer. May be used individually or as a right-hand or left-hand unit with the KT182ATF or KT182-D. Drawer faces may be specified in trim colors.</p>

<b>PACIFIC</b>	<b>Corner Display</b>	<b>Straight Display</b>	<b>Straight Display</b>	<b>Straight Display</b>
<b>Model</b>	PA180	PA181	PA183-24	PA183-36
<b>List Price</b>	\$2,804	\$2,724	\$1,282	\$1,679
<b>Specifications</b> Width (in.), footprint Depth (in.), footprint Height (in.),	41 <sup>5</sup> / <sub>16</sub> 18 <sup>3</sup> / <sub>4</sub> 84	41 <sup>5</sup> / <sub>16</sub> 17 <sup>7</sup> / <sub>8</sub> 84	24 18 84	36 18 84
<b>Specify Colors</b>	1. Main 2. Worktop and front edge	1. Main 2. Worktop and front edge	1. Main 2. Worktop and front edge	1. Main 2. Worktop and front edge
<b>Features</b>	Features: frosted glass shelves and three lower storage compartments with adjustable shelf in each compartment. Top of storage compartment may be specified as trim color.	Features: frosted glass shelves and three lower storage compartments with adjustable shelf in each compartment. Top of storage compartment may be specified as trim color.	Features: three adjustable glass shelves and lower storage compartment with adjustable shelf. Top of storage compartment may be specified as trim color. Floor cleat	Features: three adjustable glass shelves and lower storage compartment with adjustable shelf. Top of storage compartment may be specified as trim color. Floor cleat

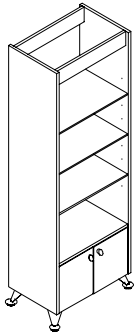
<p><b>PROFILE</b></p>	<p><b>Display Cabinet</b></p> 
<p><b>Model</b></p>	<p>PR82</p>
<p><b>List Price</b></p>	<p>\$1,405</p>
<p><b>Specifications</b></p> <p>Shipping weight (lbs.)</p> <p>Width (in.), footprint</p> <p>Depth (in.), footprint</p> <p>Height (in.),</p>	<p>104</p> <p>26<sup>1</sup>/<sub>4</sub></p> <p>16<sup>3</sup>/<sub>4</sub></p> <p>72</p>
<p><b>Specify Colors</b></p>	<p>1. Main.</p>
<p><b>Features</b></p>	<p>Tapered, ball-foot legs with matte nickel finish. Decorative slant knobs with matte nickel finish. Three adjustable glass shelves. Open top. See thru. Two doors for storage.</p>